

CHELSEA 480 C

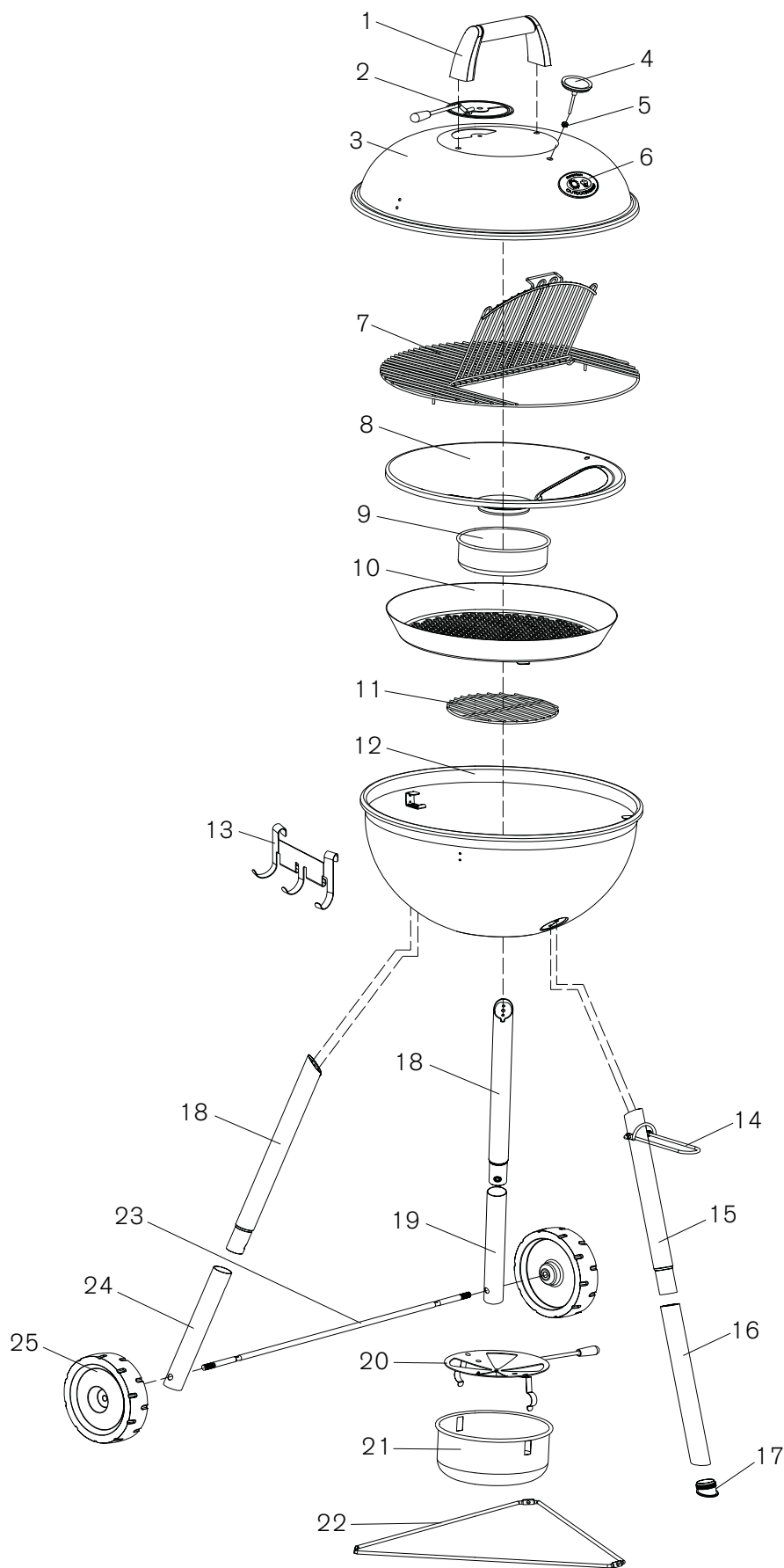

CHELSEA 480 C

B		LID	DECKEL
Pos.	Art. Nr.	Description	Beschreibung
B1	18.371.03	Teflonwasher	U-Scheibe Teflon
B2	18.371.02	Washer	U-Scheibe
B3	18.370.48	Nut	Mutter

B

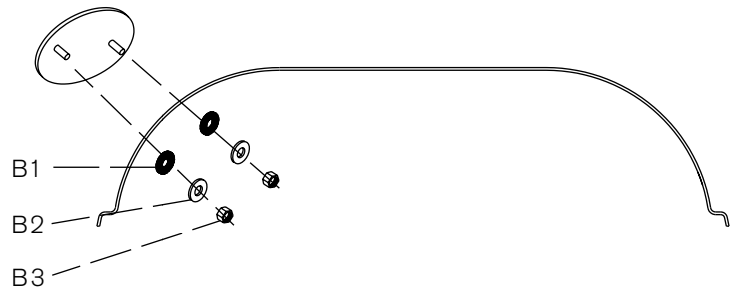
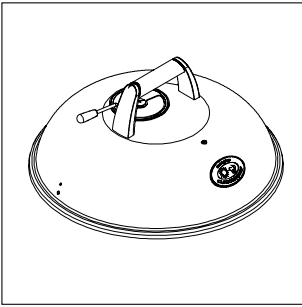

CHELSEA 480 C

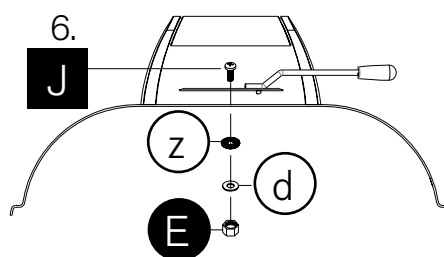
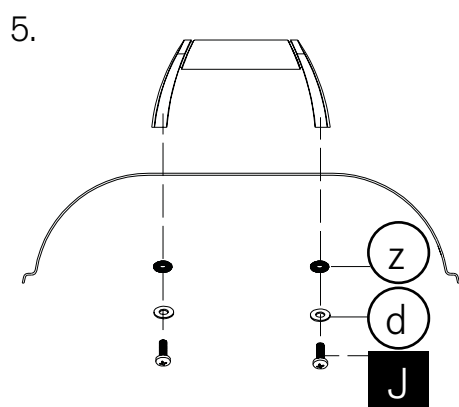
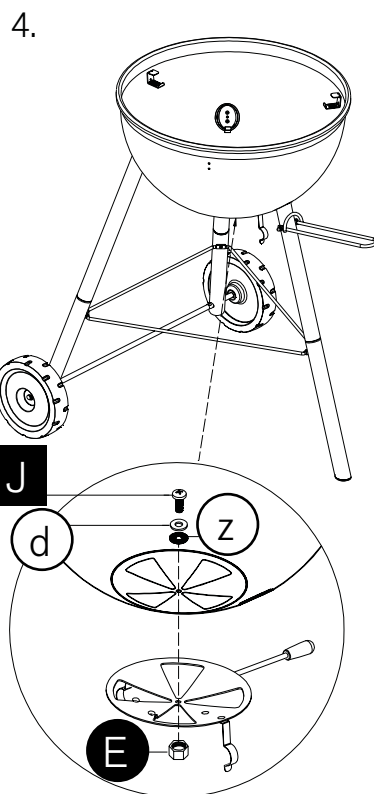
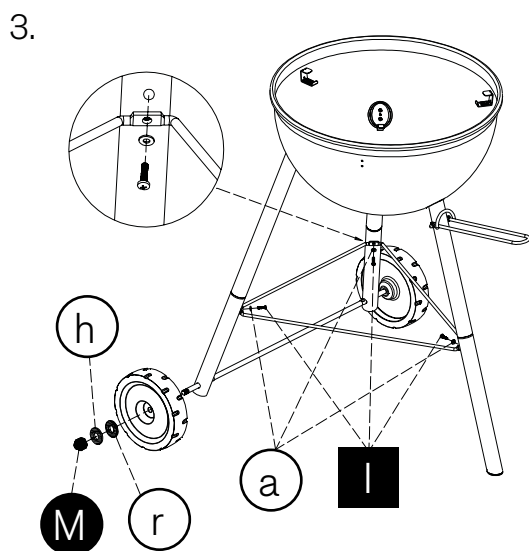
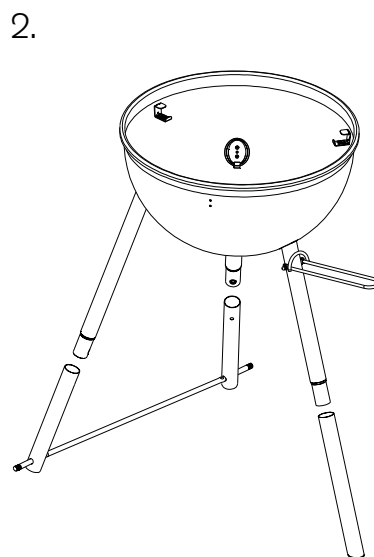
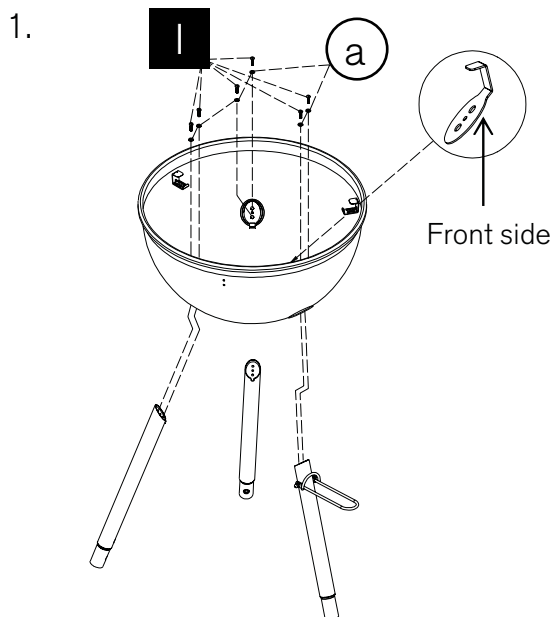

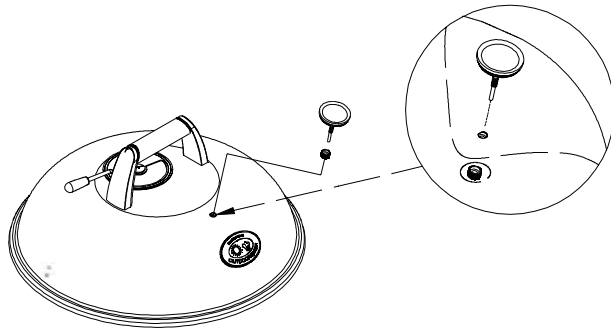

7.

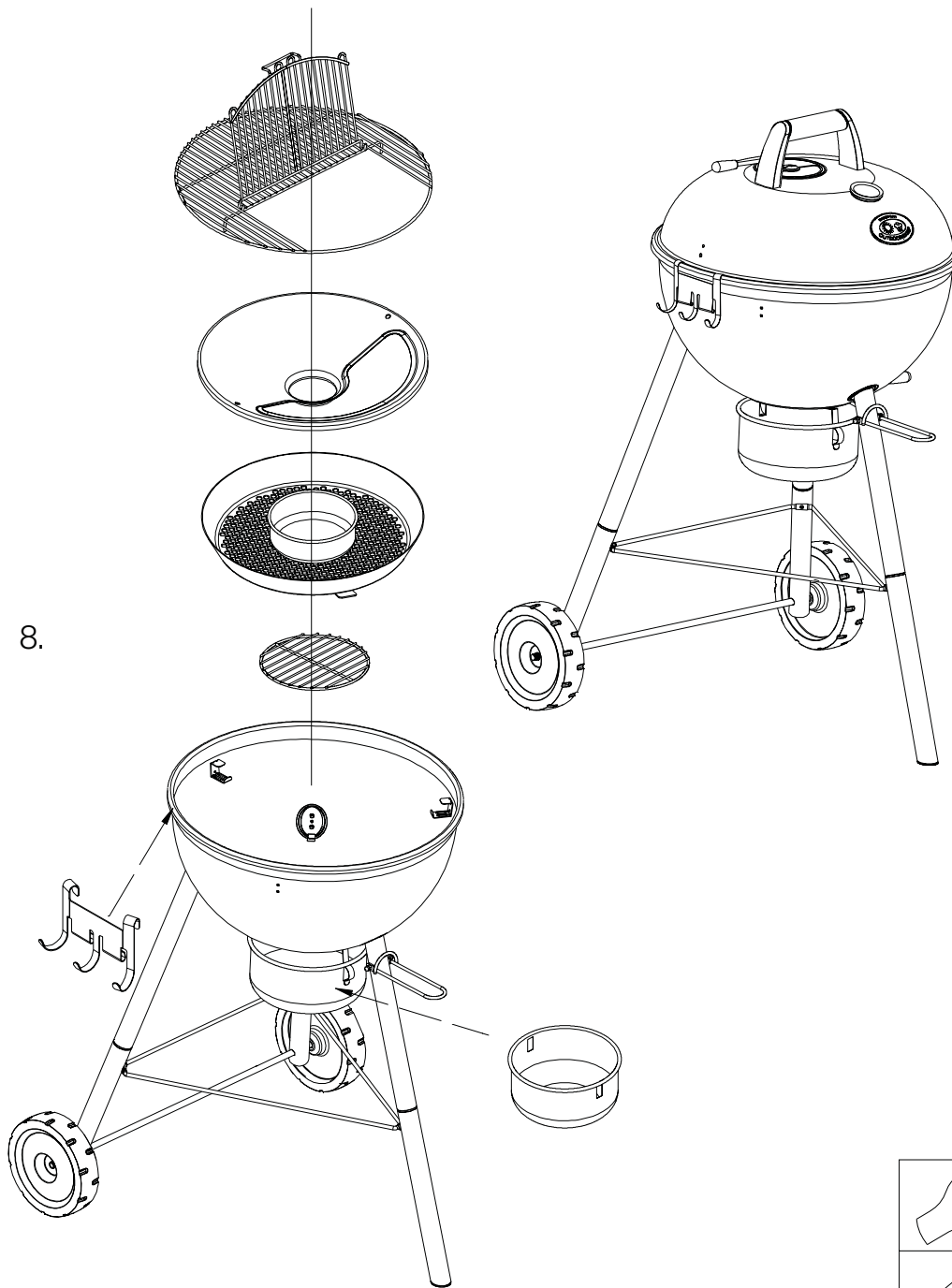

8.



	1x10 1x17
	1x2

CHELSEA 480 C

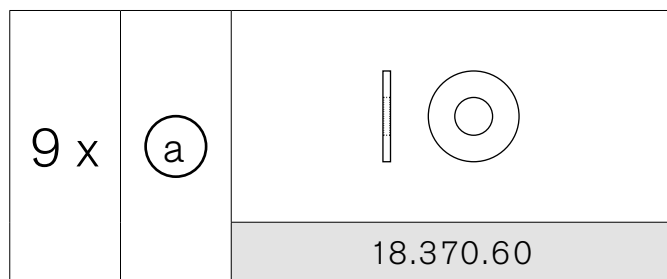
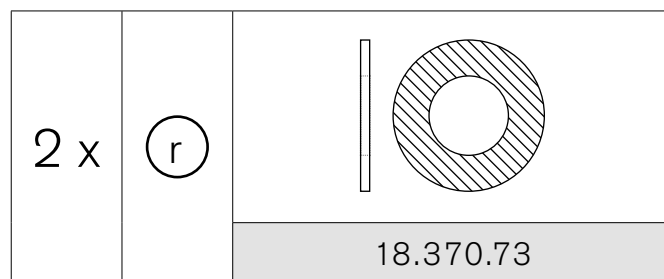
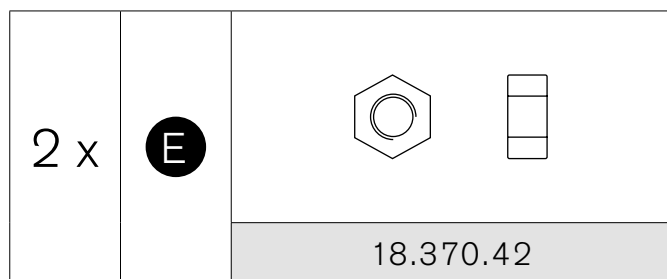
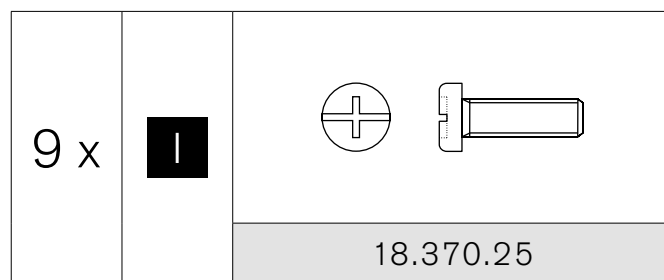
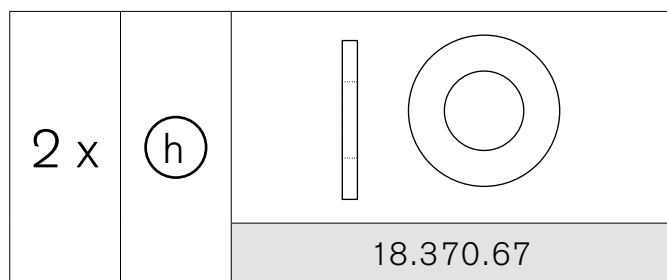
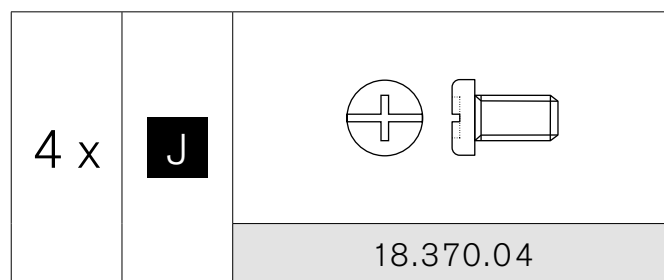
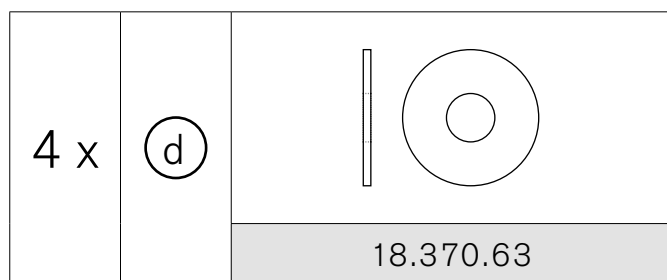
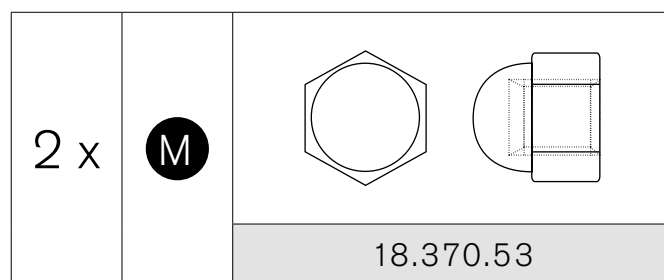
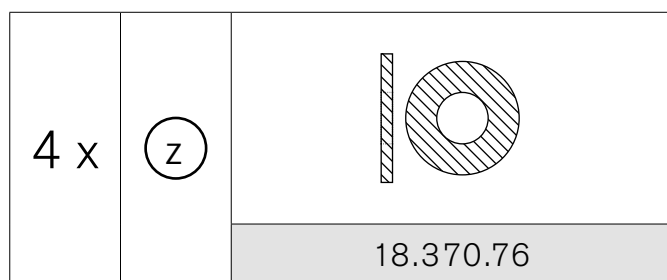

SPAREPARTS			ERSATZTEIL-LISTE
Pos.	Art. Nr.	Description	Beschreibung
1	18.450.00	Lid handle bakelite	Deckelgriff Bakelit
2	18.420.06	Upper Vent Disc with handle	Ventilationsschieber oben mit Griff
3	18.430.00	Lid black	Deckel schwarz
4	18.850.21	Heat indicator °C/°F	Temperatur Anzeige °C/°F
5	18.850.12	Heat indicator-Nut	Temperaturanzeige-Befestigungsmutter
6	18.822.49	Logo plate	Logoplatte
7	18.420.00	Cooking grid	Grillrost
8	18.420.02	Funnel	Trichter
9	18.420.03	Grease collector pan	Fettauffangschale
10	18.420.04	Charcoal grate	Kohlenrost
11	18.420.01	Booster grate	Anzünderost
12	18.430.01	Bowl black	Kugel schwarz
13	18.420.05	Tool holder	Besteck-Halter
14	18.420.15	Carry handle jetblack	Handgriff jetblack
15	18.420.10	Leg upper part front umbragrey	Bein Oberhälfte vorne umbragrau
16	18.420.13	Leg lower part front umbragrey	Bein Unterhälfte vorne umbragrau
17	18.450.01	End cap	Abschlusskappe
18	18.420.09	Legs upper part rear umbragrey	Bein Oberhälfte hinten umbragrau
19	18.420.11	Leg lower part rear right umbragrey	Bein Unterhälfte hinten rechts umbragrau
20	18.420.07	Lower vent disc with handle	Ventilationsschieber unten mit Griff
21	18.420.08	Ash catcher	Aschenschale
22	18.420.14	Stabilisation umbragrey	Stabilisation umbragrau
23	18.420.39	Wheel axle umbragrey	Radachse umbragrau
24	18.420.12	Leg lower part rear left umbragrey	Bein Unterhälfte hinten links umbragrau
25	18.450.02	Wheel	Rad
	18.379.16	Hardware set	Schraubenset

Please read the user guide carefully before using your **OUTDOORCHEF** Charcoal Kettle Barbeque.

Lesen Sie die Bedienungsanleitung sorgfältig durch, bevor Sie Ihren **OUTDOORCHEF** Holzkohle Kugelgrill in Betrieb nehmen.

Attention

Please write your serial number on the backside of the manual for future reference. You will find the number on the data plate attached to the trolley or the bottom plate depending on the grill model. **OUTDOORCHEF** can only supply spare parts and honour warranty returns when the serial number is available.

Achtung

Bitte notieren Sie auf der Rückseite Ihrer Gebrauchsanweisung die Serien-Nummer. Je nach Grillmodell finden Sie die Nummer auf dem Datensticker, welcher sich entweder am Grillgestell oder auf der Bodenplatte befindet. **OUTDOORCHEF** kann Garantie und Ersatzteillieferungen nur mit der Serien-Nummer bearbeiten.

DKB Household Switzerland AG operates a policy of continuous product development and improvement.

As such we reserve the right to alter product design and or technical specification without giving any prior notice.